

MODEL: HALO 900
Hydraulic TurboCharger
Outline Drawing

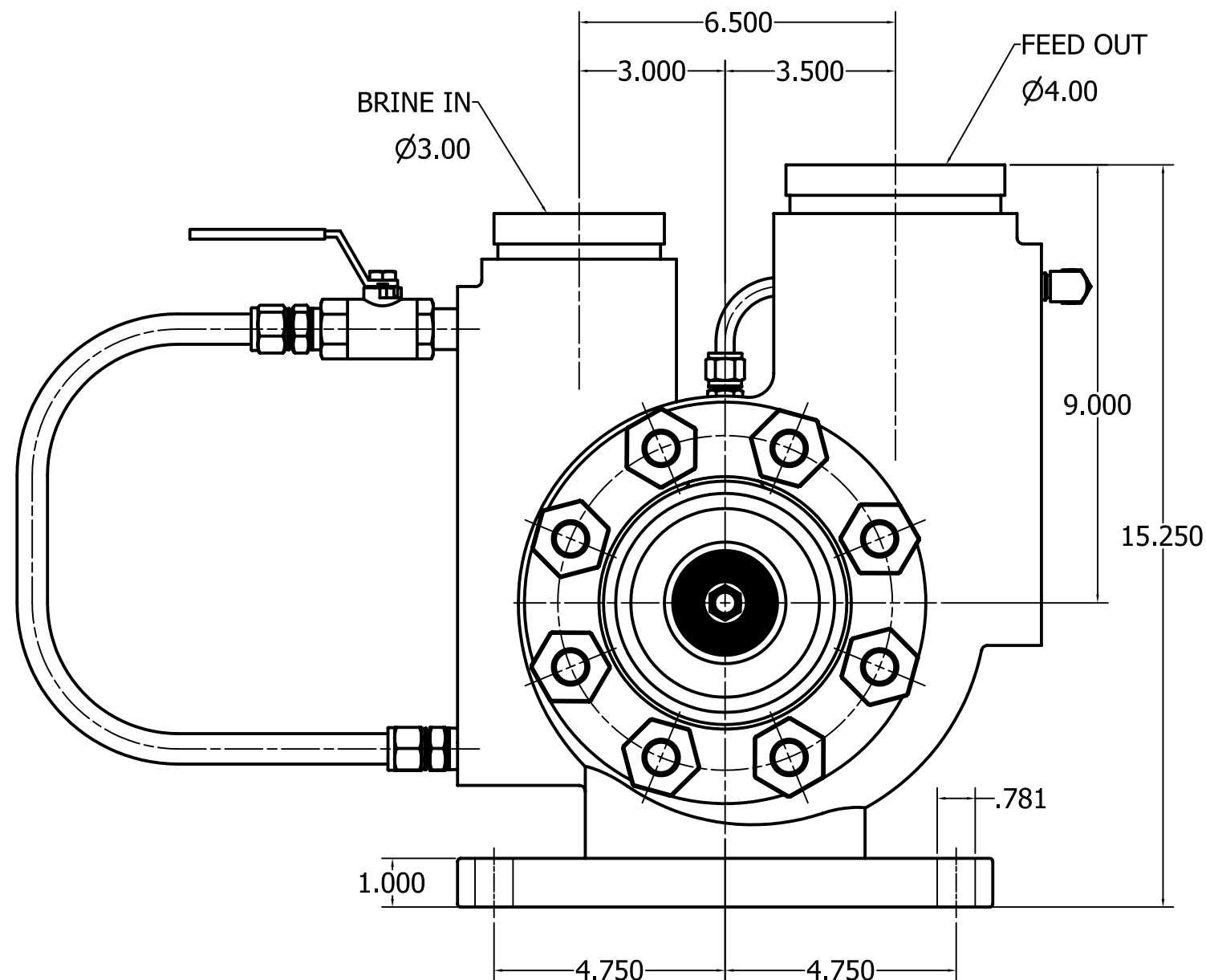
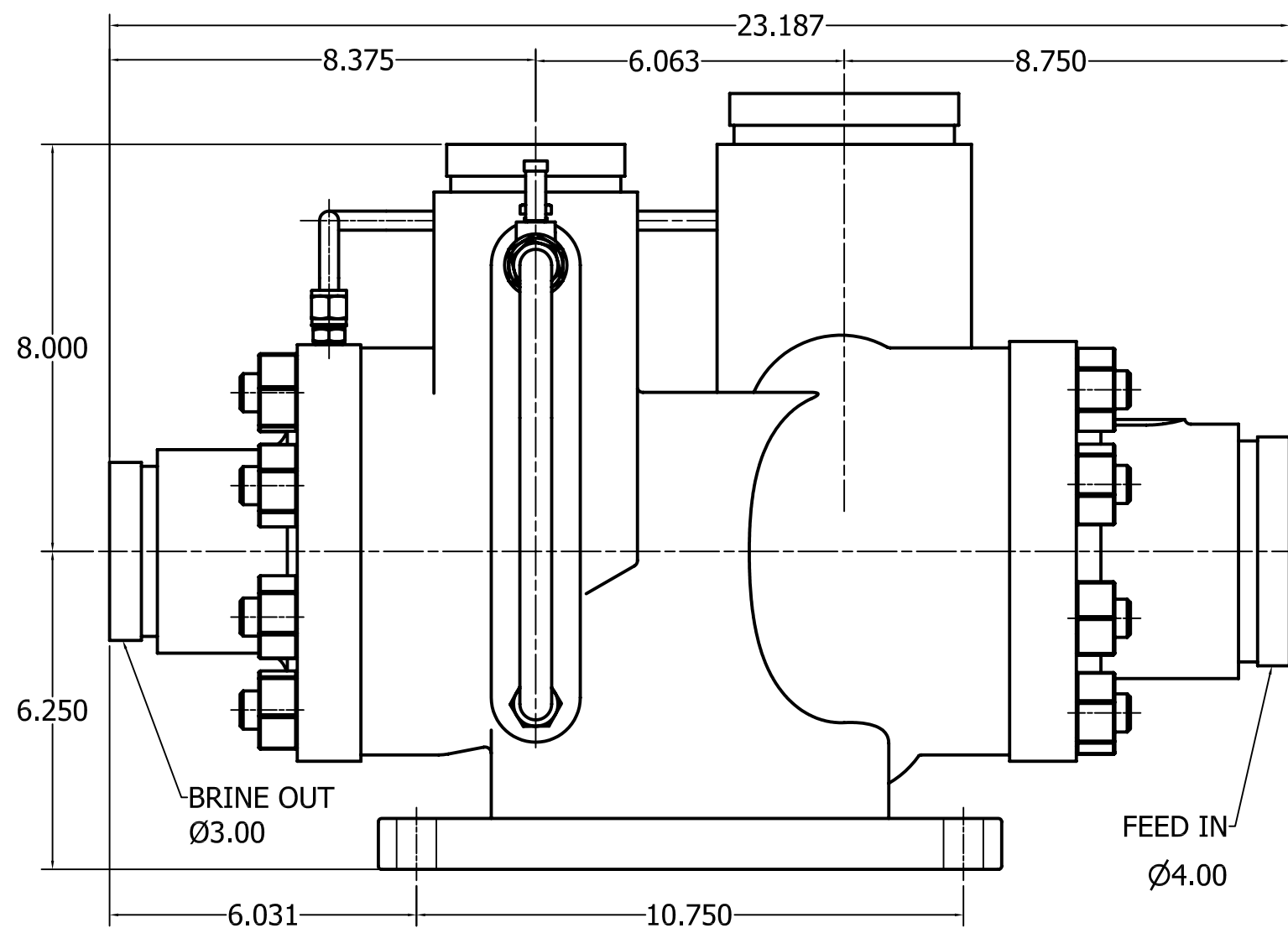

Common Specifications

Type	Brine driven feed pressure booster
Number of stages	1 turbine, 1 pump
Feed piping connection	Victaulic Style 77
Brine piping connection	Victaulic Style 77
Max. working pressure	1,200 psig
Hydro test pressure	1,800 psig
Thrust/radial bearing type	Hydrostatic/Sleeve
Rotor balancing	Dynamic

Materials (standard)

Casing	Alloy 2205 (UNS S31803)
Bolting	316 stainless steel
Rotor	Alloy 2205 (UNS S31803)
Bearings (water lubricated)	Graphite
(optional)	Ceramic
Estimated weight	280 Lbs.

*ALL DIMENSIONS IN INCHES. WEIGHT IN LBS.
DO NOT SCALE FROM DRAWING.
SEE TUBING DRAWING FOR DIMENSION
OF EXTERNAL TUBING ASSEMBLY.

Pump Engineering, Inc.

CERTIFIED CORRECT

Cust. _____
P.O. _____
S/N _____
Date _____ By _____