

MODEL: HTC AT 3600
Hydraulic TurboCharger
Outline Drawing

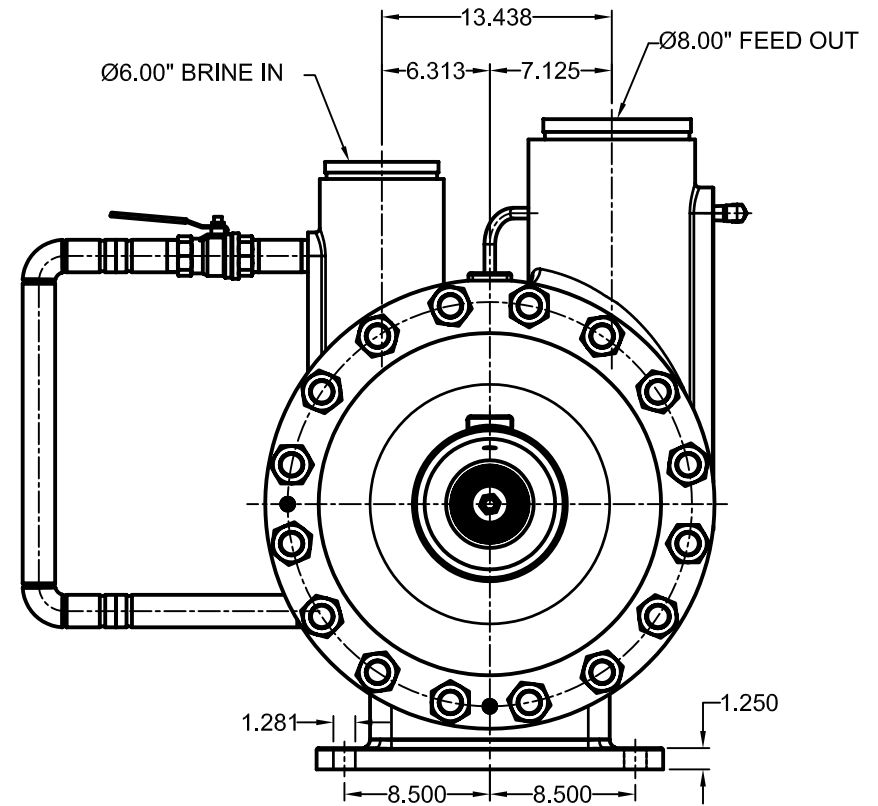
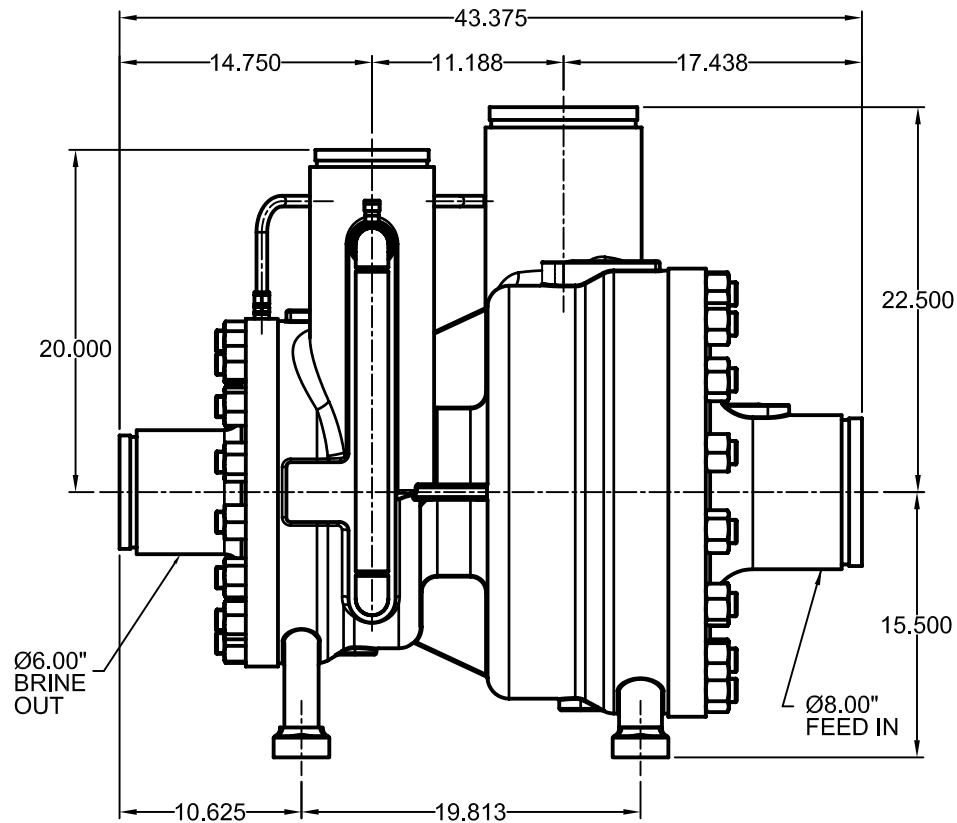

Common Specifications

Type	Brine driven feed pressure booster
Number of stages	1 turbine, 1 pump
Feed piping connection	Victaulic Style 77
Brine piping connection	Victaulic Style 77
Max. working pressure	1,200 psig
Hydro test pressure	1,800 psig
Thrust/radial bearing type	Hydrostatic/Sleeve
Rotor balancing	Dynamic

Materials (standard)

Casing	Alloy 2205 (UNS S31803)
Bolting	304 stainless steel
Rotor	Alloy 2205 (UNS S31803)
(optional)	Alloy 2507 (UNS S32750)
Turbine Nozzle	Alloy 2205 (UNS S31803)
Bearings (water lubricated)	Graphite
(optional)	Ceramic
Estimated weight	2600 Lbs.

*LENGTH IN INCHES. WEIGHT IN LBS.
DO NOT SCALE FROM DRAWING.
SEE TUBING DRAWING FOR DIMENSION
OF EXTERNAL TUBING ASSEMBLY.

Pump Engineering, Inc.

CERTIFIED CORRECT

Cust. _____
P.O. _____
S/N _____
Date _____ By _____