



PUMP ENGINEERING INC.

Harnessing the Power of Liquid Energy

HALO-100 TurboCharger

HALO - TurboCharger

The new HALO TurboCharger combines efficiency and affordability. Even RO system builders who considered energy recovery too expensive can enjoy the benefits of reduced energy consumption with this low capital cost energy recovery device. Request a quote today and be pleasantly surprised by how affordable energy recovery for sea water RO has become.

Capacity

85 gpm to 130 gpm @ 1000 psi
19.31 m³/h to 29.53 m³/h @ 68.96 bar

Delivery

Two (2) weeks standard delivery.
Priority delivery service also available.

Materials of Construction

Rotor: Duplex 2205
Bearings: Metallized Carbon M101
Casings: 316L SS or Duplex 2205

Design Features

Type The Turbo™ is an integral turbine driven centrifugal pump. The turbine is a single stage radial inflow type (similar to a reverse running pump). The pump is a single stage centrifugal type with its impeller mounted on the turbine shaft. The unit is entirely energized by the high pressure brine stream.

Product Lubricated Journal Bearings eliminate shaft seals and oil/grease lubrication and provide years of maintenance free operation.

Hydrostatic Thrust Bearing - Product lubricated thrust bearing allows turbine to run with 98% volumetric efficiency.

Multiple Turbine Nozzles The Turbo is equipped with two nozzles and a control valve that allows brine flow and pressure to be regulated without energy wasting throttling or bypassing.

Easy installation with Victaulic pipe joints. The HALO Turbo™ can be installed next to the RO trains reducing the amount of high pressure piping.

HARNESsing THE POWER OF LIQUID ENERGY

HTC AT
ADVANCED TECHNOLOGY



LPT
LOW PRESSURE



HPT
HIGH PRESSURE



HALO





HALO-100 TurboCharger

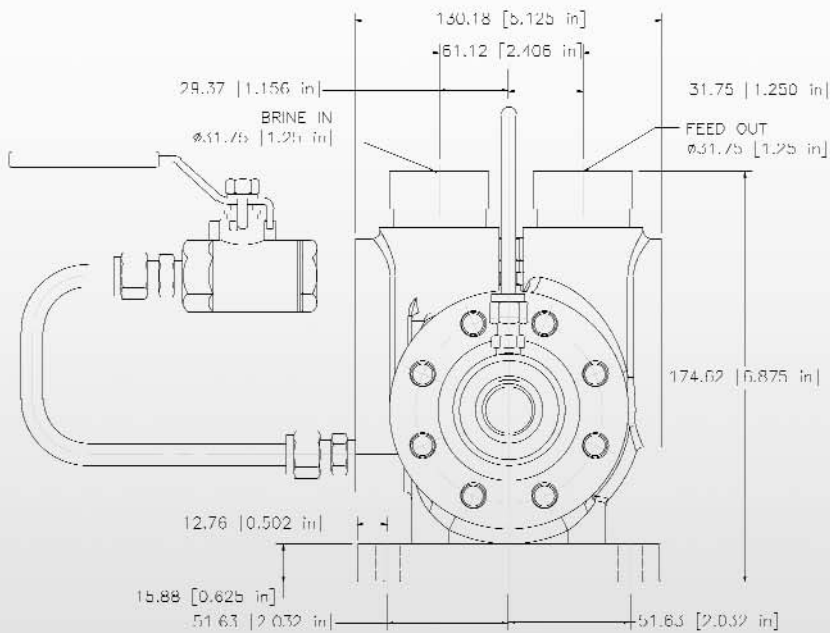
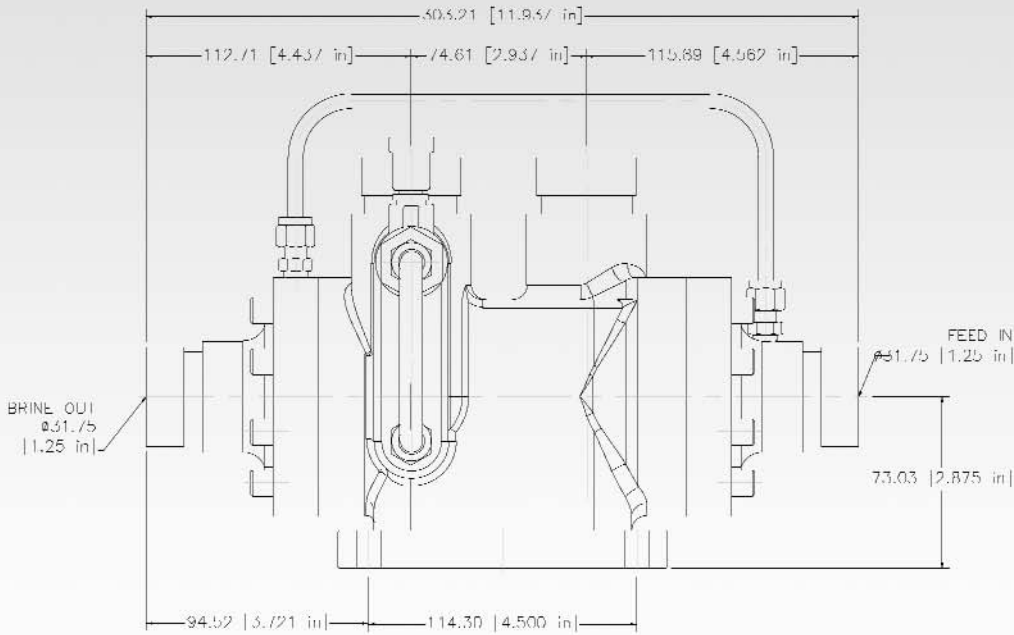

Note: Dimensions not for construction purposes.

HARNESING THE POWER OF LIQUID ENERGY

Pump Engineering Inc., was founded in 1986 for the purpose of developing and manufacturing advanced technology pumps. Since 1988 the company has focused its efforts on providing the reverse osmosis industry with the most efficient and total cost effective pumps and energy recovery equipment.



1004 West Hurd Road
 Monroe, Michigan 48162
 USA

Tel: +1 734 242 1772
 Fax: +1 734 242 9777

www.pumpengineering.com